

c. 3

TIC-14 REPORT COLLECTION
**REPRODUCTION
COPY**

*Application of Electrodialysis to the Recovery
of Spent Electrorefining Salts. Plutonium
Recovery and Waste Minimization*

Los Alamos
NATIONAL LABORATORY

*Los Alamos National Laboratory is operated by the University of California
for the United States Department of Energy under contract W-7405-ENG-36.*



LOS ALAMOS NATIONAL LABORATORY
3 9338 00285 1763

Edited by Virginia Cleary, Group CIC-1

An Affirmative Action/Equal Opportunity Employer

This report was prepared as an account of work sponsored by an agency of the United States Government. Neither The Regents of the University of California, the United States Government nor any agency thereof, nor any of their employees, makes any warranty, express or implied, or assumes any legal liability or responsibility for the accuracy, completeness, or usefulness of any information, apparatus, product, or process disclosed, or represents that its use would not infringe privately owned rights. Reference herein to any specific commercial product, process, or service by trade name, trademark, manufacturer, or otherwise, does not necessarily constitute or imply its endorsement, recommendation, or favoring by The Regents of the University of California, the United States Government, or any agency thereof. The views and opinions of authors expressed herein do not necessarily state or reflect those of The Regents of the University of California, the United States Government, or any agency thereof.

*Application of Electrodialysis to the Recovery
of Spent Electrorefining Salts. Plutonium
Recovery and Waste Minimization*

*Douglas E. Wedman
Wayne H. Smith*



APPLICATION OF ELECTRODIALYSIS TO THE RECOVERY OF SPENT ELECTROREFINING SALTS. PLUTONIUM RECOVERY AND WASTE MINIMIZATION

by

Douglas E. Wedman and Wayne H. Smith

ABSTRACT

A two-stage electrodialysis is investigated as an alternate method for the separation of plutonium and other heavy metals from aqueous chloride salt solutions. The first stage of the process separates heavy metals from solution through the formation of insoluble metal hydroxides within a three compartment electrodialysis cell. The second stage of the process utilizes a salt-splitting electrodialysis to generate hydrochloric acid (3.8 M) and a mixture of sodium and potassium hydroxide (6 M). A material balance and proposed flow sheet for batch processes are included.

Introduction

Several processes used in the recovery and purification of plutonium are carried out in high temperature molten salts. These include molten salt extraction (MSE) for the separation of metallic plutonium from americium and other fission products, direct oxide reduction (DOR) for the conversion of plutonium oxide to plutonium metal, and electrorefining (ER), which converts low purity metal to the high purity product. Associated with each of these processes is a spent molten salt residue that must be treated to remove the residual plutonium and other radioactive elements before it can be discarded. Several processes, both aqueous and nonaqueous have been developed to treat these residues.

The aqueous recovery operations usually involve dissolution of the spent salts in concentrated hydrochloric acid, followed by one or more ion exchange steps or a combination of ion exchange and solvent extraction. An overall process flow sheet is shown in Figure 1. Each of these processes is reagent intensive, resulting in large volumes of solution that must be treated prior to disposal.

Electrodialysis is a widely used industrial process for the removal of salt from aqueous solution. A typical electrodialysis process is shown in Figure 2. The apparatus consists of a three-compartment cell with each compartment separated by a porous polymeric ion exchange membrane. The cell is sandwiched by a pair of electrodes. At the cathode, water molecules are reduced to hydrogen gas and hydroxide ion; while at the anode, water is oxidized to oxygen and protons. The charge build-up at each of the electrodes is alleviated by the migration of ions from the central feed solution containing the salt. Separating the feed and anolyte solutions is an anion exchange membrane permeable only to anions. This allows the transport of the salt anions from the feed to the anolyte while blocking the flow of protons in the opposite direction. Separating the feed

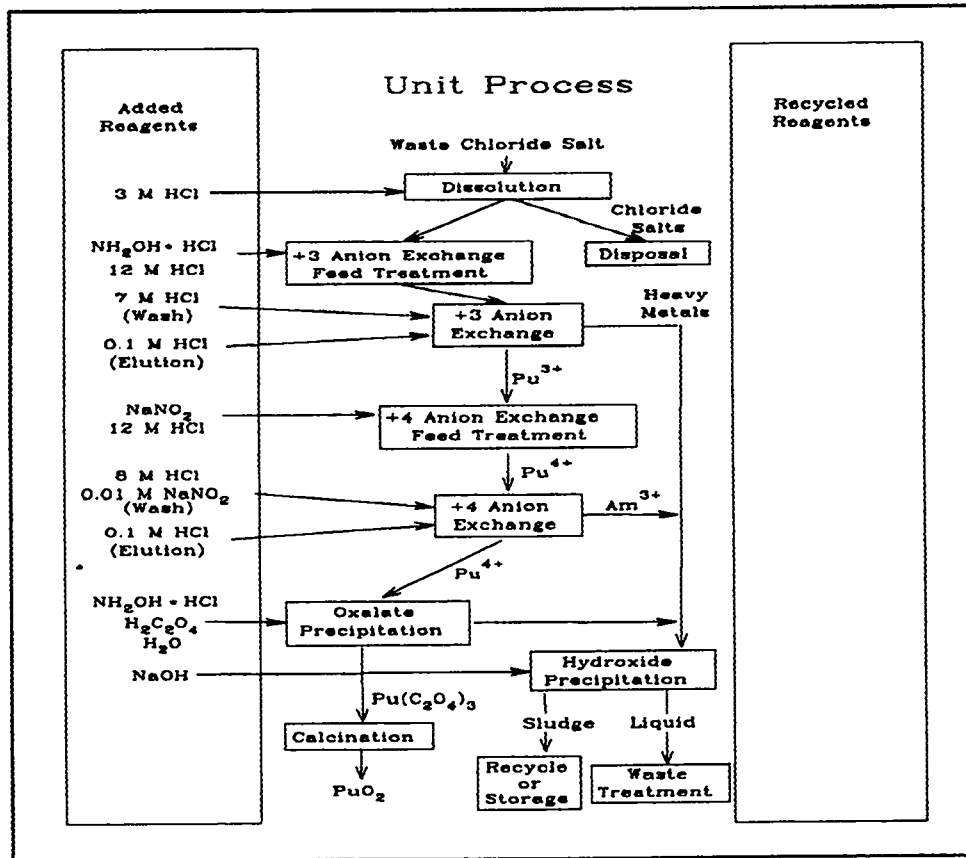

Figure 1: The overall process flow sheet currently followed during aqueous chloride recovery operations. An excessive amount of chemical reagents are added and none recycled.

and catholyte solutions is a cation exchange membrane that allows transport of cations from the feed to catholyte solution while preventing anion flow in the opposite direction. The net result is the removal of salt from the feed solution with conversion into its acid and base components in the anolyte and catholyte, respectively.

The current aqueous recovery flow sheet uses hydrochloric acid in the dissolution of

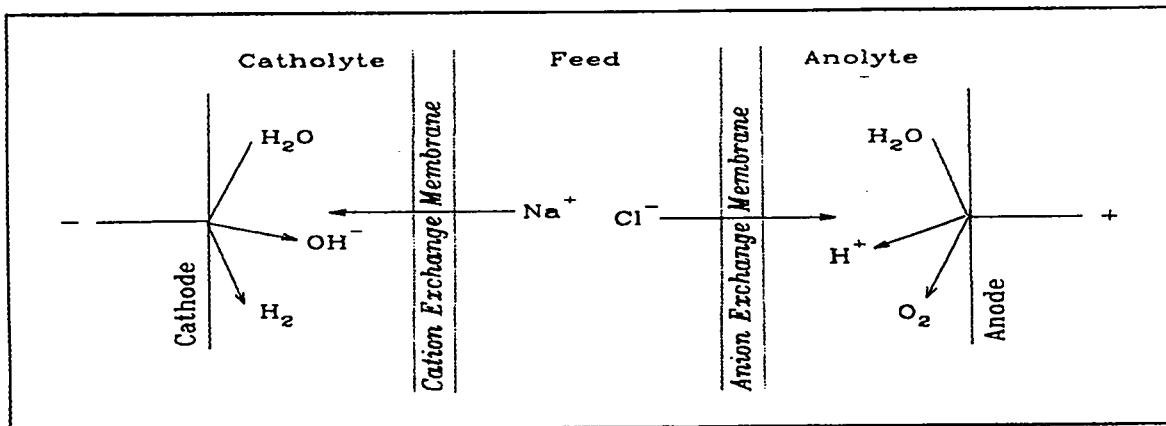

Figure 2: Schematic of a typical electro dialysis process. A three compartment cell is used to split sodium chloride into sodium hydroxide and hydrochloric acid.

the spent salts and the addition of caustic solution as a final polishing step for the waste solutions resulting from the recovery operations. These reagents are generated during an electro dialysis of chloride based salt solutions. Thus adding an electro dialysis step to the aqueous recovery operations and recycling the solutions generated would significantly decrease the quantity of reagents necessary to carry out the operations and would simultaneously decrease the quantity of spent salt sent for disposal.

The original intent was to fit an electro dialysis step into the existing aqueous recovery process flow sheet as a treatment for current effluent streams. However, we were unable to adapt electro dialysis to any of the existing process streams. We then proposed an entirely new flow sheet centered on electro dialysis. This flow sheet is shown in Figure 3. The first spent salts investigated were the electrorefining salt residues, which are composed of an equimolar mixture of sodium and potassium chlorides. Because of their lack of chemical complexity, we chose them to demonstrate proof of principle.

Electrodialysis Configurations

The proposed flow sheet has two separate electro dialysis stages. The purpose of the first stage is to precipitate the heavy metal impurities from the chloride salts; the second to

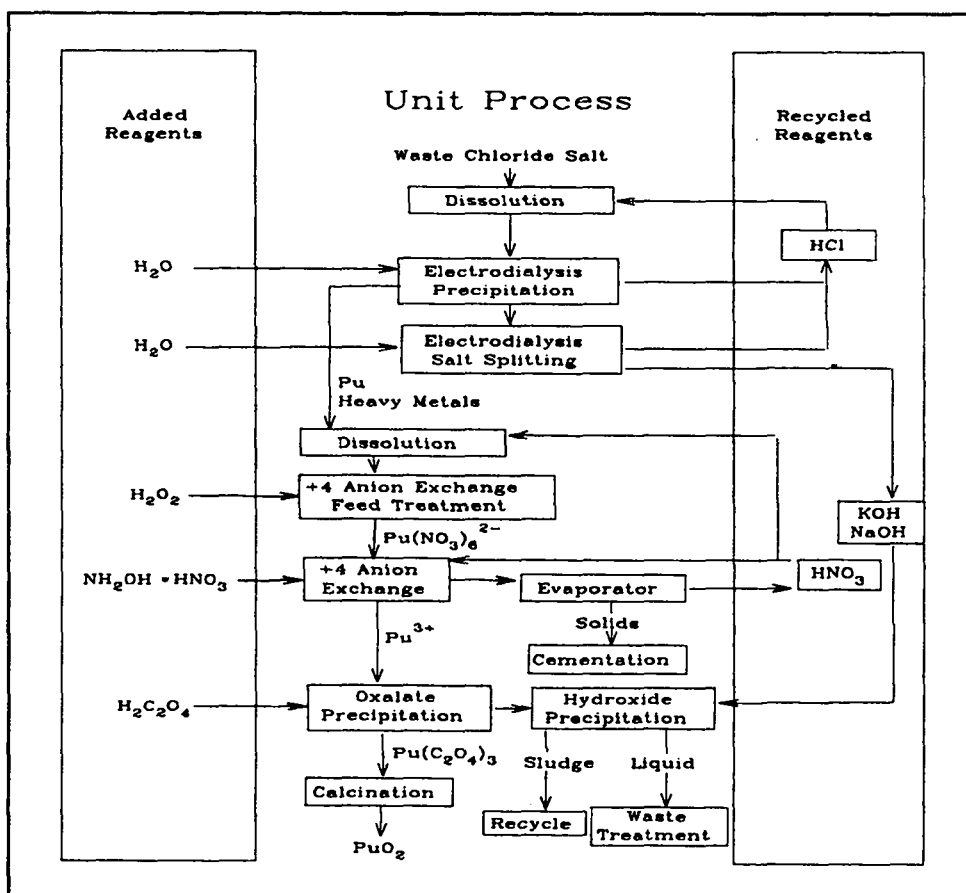

Figure 3: Proposed flow sheet for aqueous chloride recovery operations based on electro dialysis as the core technology.

split the salts into their corresponding acid and base components. Slightly different configurations are necessary to accomplish these goals. The former process uses a three compartment cell with the following configuration: cathode/ feed solution/ anion exchange membrane/ water/ cation exchange membrane/ 0.2 M sulfuric acid/ anode. This configuration is presented in Figure 4. The spent salts are dissolved in a minimum amount of 1.0 M hydrochloric acid, then sent to the cathode compartment. Here the solution pH gradually becomes more basic during the electrolysis as hydroxide ions are generated at the cathode. The excess negative charge build-up is alleviated by the flow of chloride ions through the anion exchange membrane to the central compartment. When the catholyte becomes sufficiently basic, the heavy metals, including the actinide elements, begin to precipitate as the insoluble hydroxide species. These precipitates are collected on a filter that has been placed in the recirculating catholyte stream.

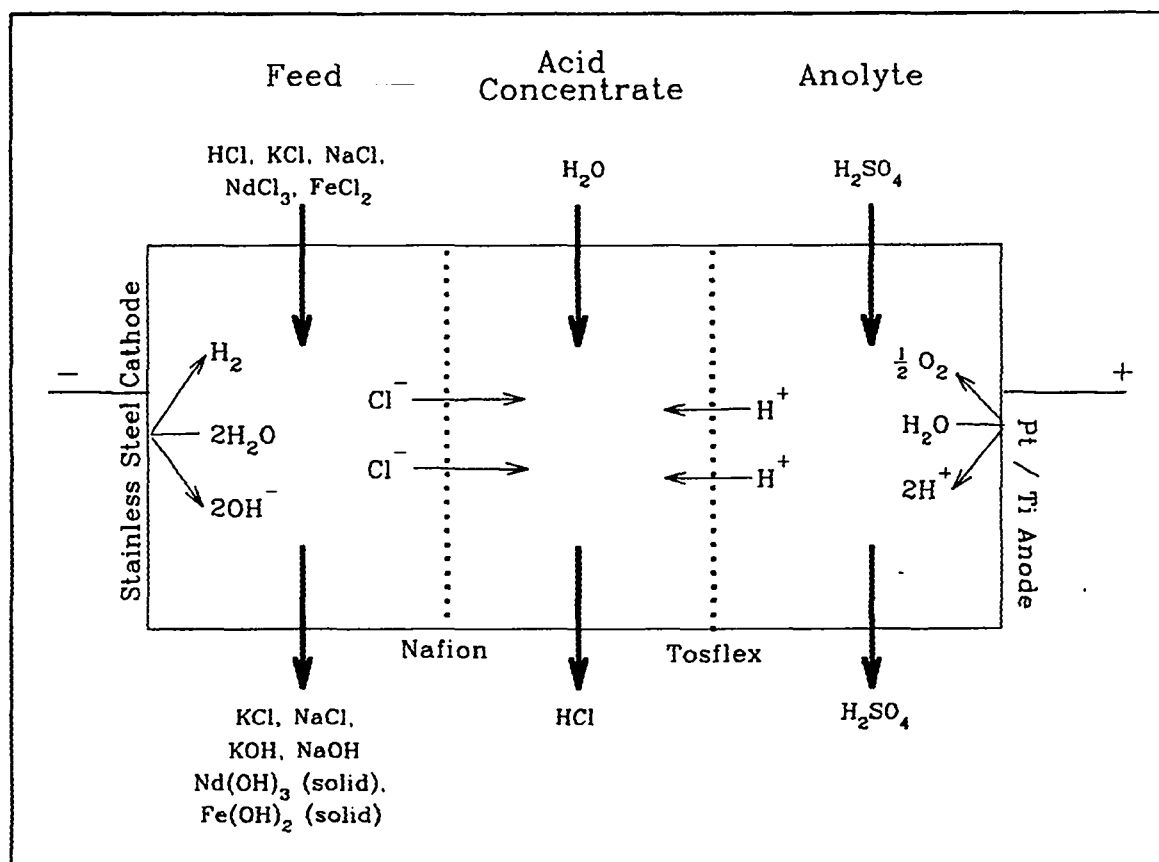

Figure 4: Three-compartment cell for the precipitation of heavy metals from a chloride feed.

If the chloride were allowed to reach the anode, it would be oxidized to undesirable chlorine gas. To prevent this from occurring, we placed a cation exchange membrane between the middle solution and the anolyte. Protons are generated at the anode, which then migrate into the central compartment to unite with the chloride and form hydrochloric acid. The anolyte, which consists of dilute sulfuric acid, remains essentially unchanged during the electrolysis since protons migrate to the central compartment at the same rate at which they are generated at the anode.

The second electrodiagnosis stage uses a four-compartment configuration: cathode/ water/ cation exchange membrane/ feed solution/ anion exchange membrane/ water/ cation exchange membrane/ 0.1 M sulfuric acid/ anode. As shown in Figure 5, salt is stripped from the feed stream and collected as concentrated base in the catholyte and as concentrated hydrochloric acid in the acid concentrate stream. The anolyte is the same as that in the previous set-up and, as before, remains essentially unchanged during the electrolysis.

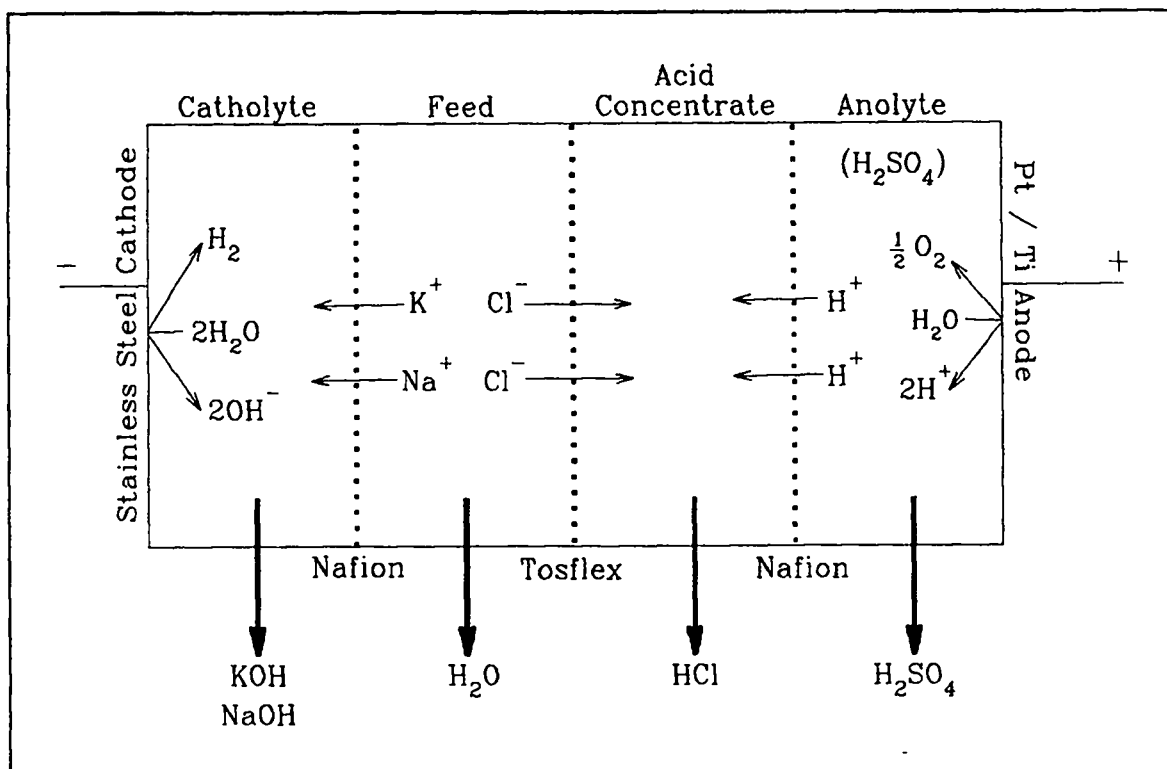

Figure 5: Diagram of a four-compartment electrodiagnosis cell for the second electrodiagnosis stage.

Experimental Procedures

In addition to potassium and sodium chlorides, the spent ER salts also contained a significant quantity of plutonium and other heavy metals, principally iron. To allow cold lab testing, we prepared a salt containing sodium and potassium chloride in an approximate 1:1 molar ratio and 0.3 wt% $\text{FeCl}_2 \cdot 4\text{H}_2\text{O}$ with 2 wt% $\text{NdCl}_3 \cdot 6\text{H}_2\text{O}$ added as a surrogate for plutonium. All reagents were of reagent grade or higher purity.

Approximately 1.6 kg of this mixture was dissolved to 6.5 L in 1.0 M HCl. This solution was very near saturation and had to be stirred overnight for complete dissolution. The resulting solution was the feed stream for the first electrodiagnosis step.

All electrodiagnosis measurements were made using a standard plate and frame cell, an Electro Cell AB model MP Cell obtained from the Electrosynthesis Company, Inc. The

electrode pair consisted of a stainless steel cathode and a platinized titanium anode. The effective electrode area was 100 cm². Tosflex¹ DF-34 anion exchange and Nafion² 350 cation exchange membranes were used as cell dividers. The membranes were soaked overnight in 0.5 M sodium chloride solution before being installed in the cell.

Power to the cell was provided with a Sorensen DCR-B series 1000 W power supply. The cell was maintained in a galvanostatic (controlled current) mode throughout the electrolysis. An Electrosynthesis model 640 digital coulometer connected across a 100X shunt was used to monitor the total electricity passed.

Figure 6 details the plumbing configuration of the cell, reservoirs, and filter for the first stage process. Each of the three streams had a 5 L Nalgene³ bottle reservoir. Each stream was circulated through the cell by a March model TE-MDK-MT3 magnetically coupled impeller pump. A second pump was added to the feed stream to aid in pushing the solution through the filter. This action was made necessary by the gelatinous nature of the precipitate, which quickly plugged the filter.

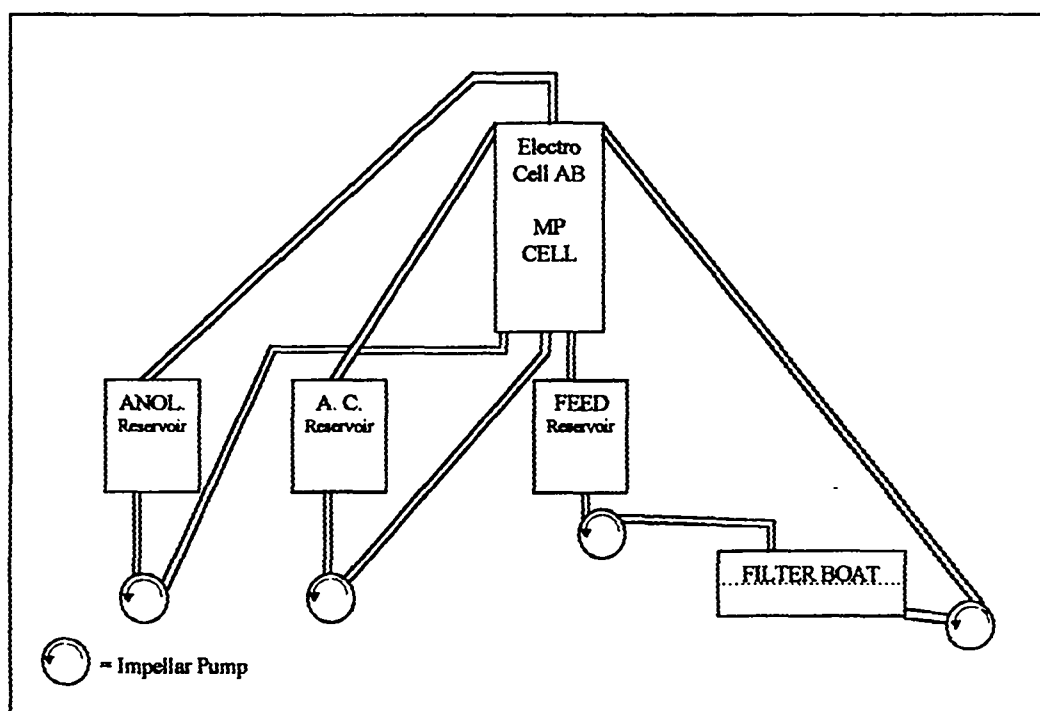

Figure 6: Plumbing configuration of the electro dialysis cell for the first stage process.

The filter consisted of a high-density polyethylene (HDPE) frit (23 cm diameter, 0.64 cm thick, 70 μm pores) supporting a piece of filter paper (23 cm diameter, 25 μm pores) sandwiched into a polyvinylidene difluoride (PVDF) filter boat. Mills clamps were used to hold the filter boat together, allowing pressurization of the head side when the pressure drop across the filter became large.

During the electrolysis 5 mL sample aliquots were periodically removed for later analysis. These samples were analyzed for sodium, potassium, chloride, iron, neodymium, and proton (or hydroxide) concentrations by the methods outlined in Table 1.

Table 1: Methods used for analysis of electro dialysis samples.

Ion	Method of Analysis	Detection Limit*
Proton	Titration with NaOH; potentiometric endpoint determination	2e-4 M
Hydroxide	Titration with HCl; potentiometric endpoint determination	2e-5 M
Chloride	Titration with AgNO ₃ ; potentiometric endpoint determination	1e-5 M
Potassium	ISE [†] ; standard addition method	2e-3 M
Sodium	ISE [†] ; standard addition method	2e-3 M
Iron	Spectroscopic determination of complex with <i>o</i> -phenanthraline	1e-5 M
Neodymium	Spectroscopic determination of complex with arsenazo III	1e-5 M

* Detection limits refer to the lowest concentrations deemed detectable under the specific conditions of these analysis.

† Ion-specific electrode.

Results

The starting conditions for a typical stage one electro dialysis experiment are presented in Table 2. The starting acid concentrate volume was significantly lower than that of the feed volume to allow generation of as high a concentration of hydrochloric acid as possible. The applied current was 30 amperes (current density 0.3 A/cm²) with an imposed upper voltage limit of 25 volts. During the electrolysis the voltage ranged from 7.5 to 8.5 volts.

Table 2: Conditions at the start of a typical stage one electro dialysis.

Experimental Component	Compartment		
	Feed	Acid Concentrate	Anolyte
Volume	6.5 L	1.0 L	3.0 L
HCl	1.00 M	—	—
H ₂ SO ₄	—	—	0.2 M
KCl	1.8 M	—	—
NaCl	1.8 M	—	—
NdCl ₃ · 6H ₂ O	0.014 M	—	—
FeCl ₂ · 4H ₂ O	0.004 M	—	—

Changes in feed ion concentrations during a run are presented in Figure 7. The most significant changes were in the proton, chloride, and heavy metal ion concentrations. The proton concentration decreased at a fixed rate at constant current density due to the steady generation of hydroxide ion at the cathode. The efficiency for this process was low

(about 52%) presumably due to current leakage through the MP Cell baffles at this high current density. At 1.2×10^6 coulombs, the original 1.0 M acid was totally neutralized and the pH changed dramatically from acidic to alkaline. There was a corresponding decrease of approximately 1 M chloride concentration as chloride ion migrated through the anion exchange membrane to maintain charge balance. When the solution turned alkaline, there was an immediate decrease in iron and neodymium concentrations as they precipitated as insoluble hydroxide species. The slight apparent increase in cation concentration during the electrolysis was due primarily to loss of water by electroosmosis to the acid concentrate solution.

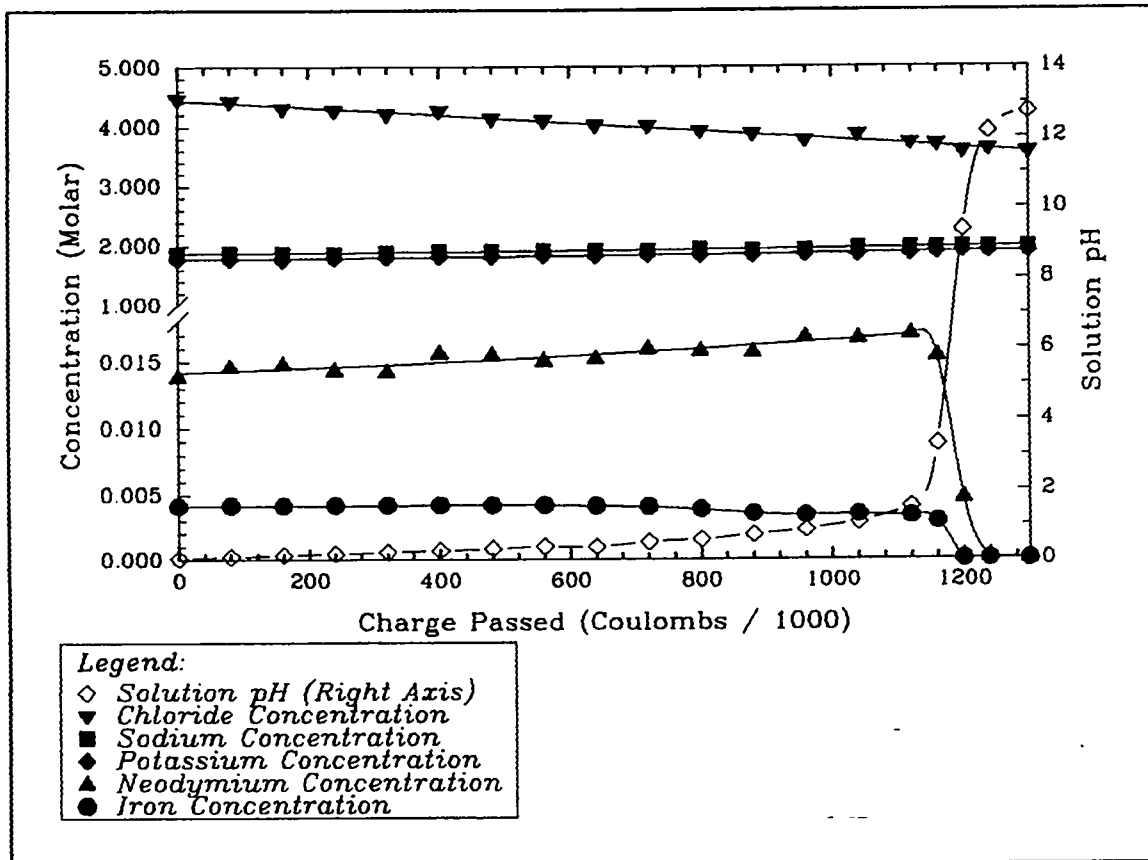

Figure 7: Changes in feed ion concentrations during a stage one electrodiolysis.

Acid concentrate and anolyte concentration changes are presented in Figure 8. The hydrochloric acid concentration in the acid concentrate approached a maximum of approximately 3 M. The upper limit of acid concentration was determined by the waters of hydration that accompanied the chloride and hydrogen ions that migrated into the center compartment. After a total of approximately 6.5 moles of each ion had transferred, the solution volume increased by approximately 1.1 liter. Thus an average of about 9.5 molecules of water accompanied each molecule of hydrogen chloride. This sets the upper theoretical concentration limit at just under 6 M. However, the permselectivity of the anion exchange membrane decreased with increasing acid concentration. As the acid concentration increased there was an increased current component due to migration of

protons through the anion exchange membrane into the catholyte compartment. This phenomenon set a practical upper acid concentration at approximately 3.5 M.

The proton and sulfate concentrations in the anolyte compartment appeared to increase slightly during the electrolysis. This was due to a decrease in solution volume rather than to ion migration. There was no evidence for chloride migration into this compartment from the acid concentrate, even at high concentrations, showing that the cation exchange membrane was much better at excluding anions than the anion exchange membrane was at excluding protons.

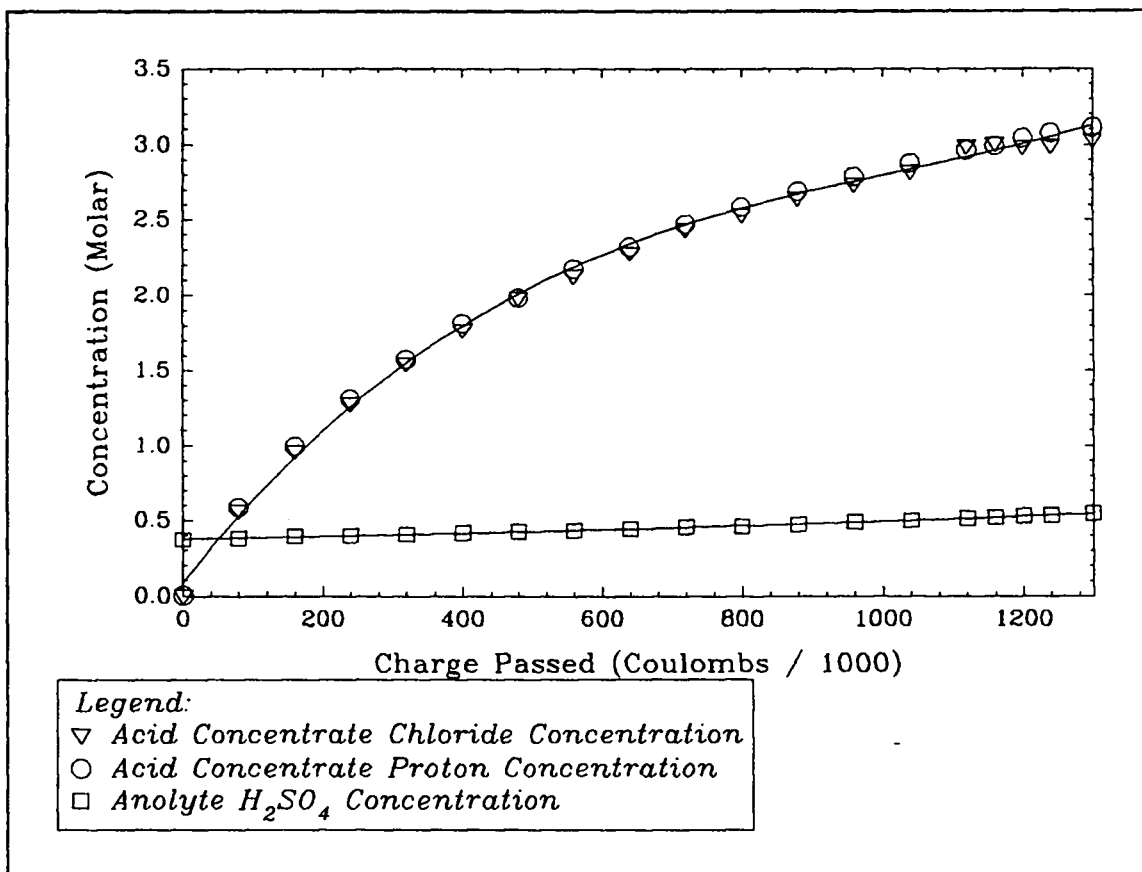

Figure 8: Concentration changes in acid concentrate and anolyte during a stage one electro dialysis.

A mass balance for the first stage process is shown in Figure 9. We dissolved 1.6 kg of salt in 6.5 L of 0.91 M hydrochloric acid and determined that the resulting solution was 1.76 M in potassium chloride and 1.81 M in sodium chloride. The concentrations of neodymium chloride and iron(II) chloride were 0.014 M and 0.004 M, respectively.

This solution was fed into the catholyte compartment of the three compartment electro dialyzer. Then 1.0 L of deionized water was fed into the cell as the acid concentrate, and 3.0 L of 0.19 M sulfuric acid was fed into the cell as the anolyte. The electrolysis was continued until the catholyte pH surpassed 12. The resulting catholyte volume was 6.2 L and had the following composition: 1.90 M sodium, 1.85 M potassium, 0.06 M hydroxide, and 3.69 M chloride.

During the process, 3.3 moles of oxygen and 6.7 moles of hydrogen were evolved at the anode and cathode, respectively. Precipitated and collected on the filter were 0.091 moles of $\text{Nd}(\text{OH})_3$ and 0.026 moles of $\text{Fe}(\text{OH})_2$. Generated in the acid concentrate were 2.0 L of 3.28 M HCl. The anolyte volume decreased by 0.95 L, resulting in a final sulfuric acid concentration of 0.27 M.

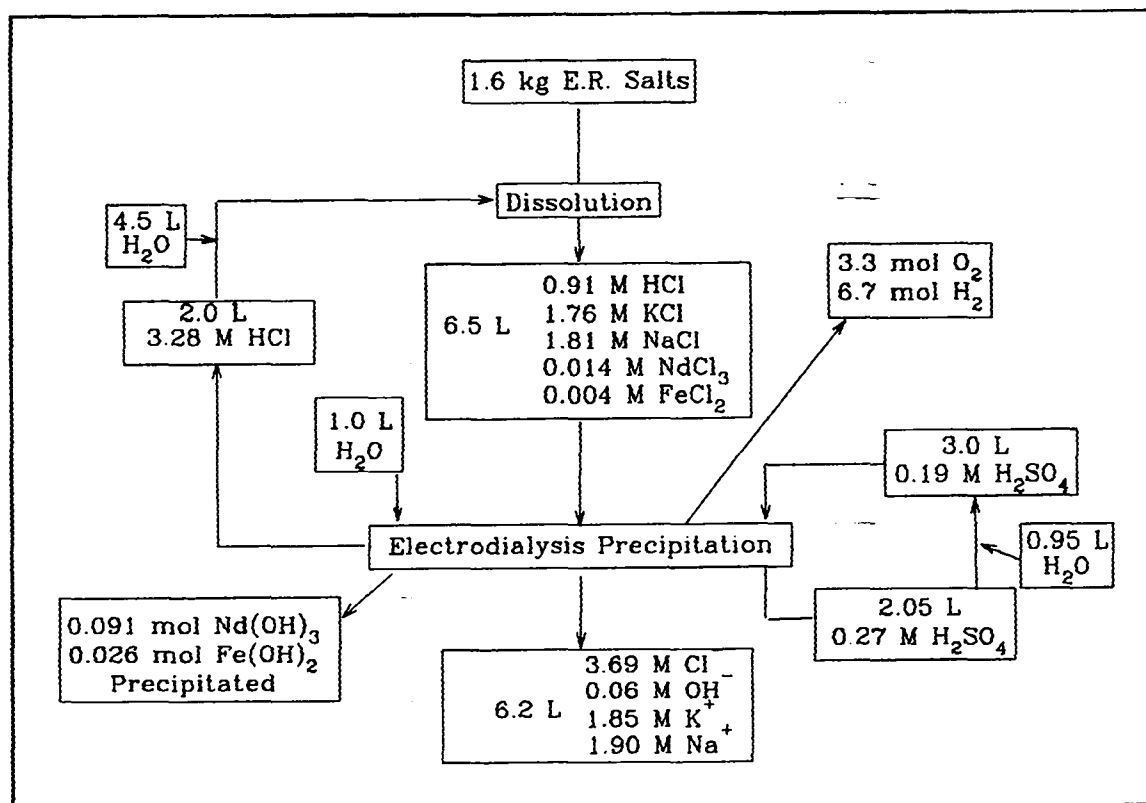

Figure 9: Mass balances for first stage electrodiolysis.

The second stage electrodiolysis was not carried out on the solution resulting from the first stage. Instead, a different solution was made with a composition differing in some respects from the solution resulting from stage one. The reason for this differentiation was that the stage two electrolysis was carried out before the stage one electrodiolysis.

The feed solution for the second stage electrolysis was 4.0 L of a pH 7.0 solution containing initially a 1:1 molar ratio of potassium chloride and sodium chloride. The total concentration of chloride was 2.4 M. The catholyte and acid concentrate were 0.5 L each of water. The anolyte was 4.5 L of 0.3 M sulfuric acid.

The changes in the composition of the feed solution during the run are presented in Figure 10. The most notable feature is the change in solution pH. Very early in the electrolysis the proton concentration rose in the feed compartment because of a breakdown in the permselectivity of the anion exchange membrane separating the feed compartment from the adjacent acid concentrate compartment. The concentration of hydrochloric acid in the acid concentrate compartment also rose quickly, resulting in an increasing current component due to proton migration from the acid concentrate compartment. After reaching a maximum feed concentration of about 0.5 M, the proton

concentration began to fall due to an increasing transference of protons from the feed solution to the catholyte compartment.

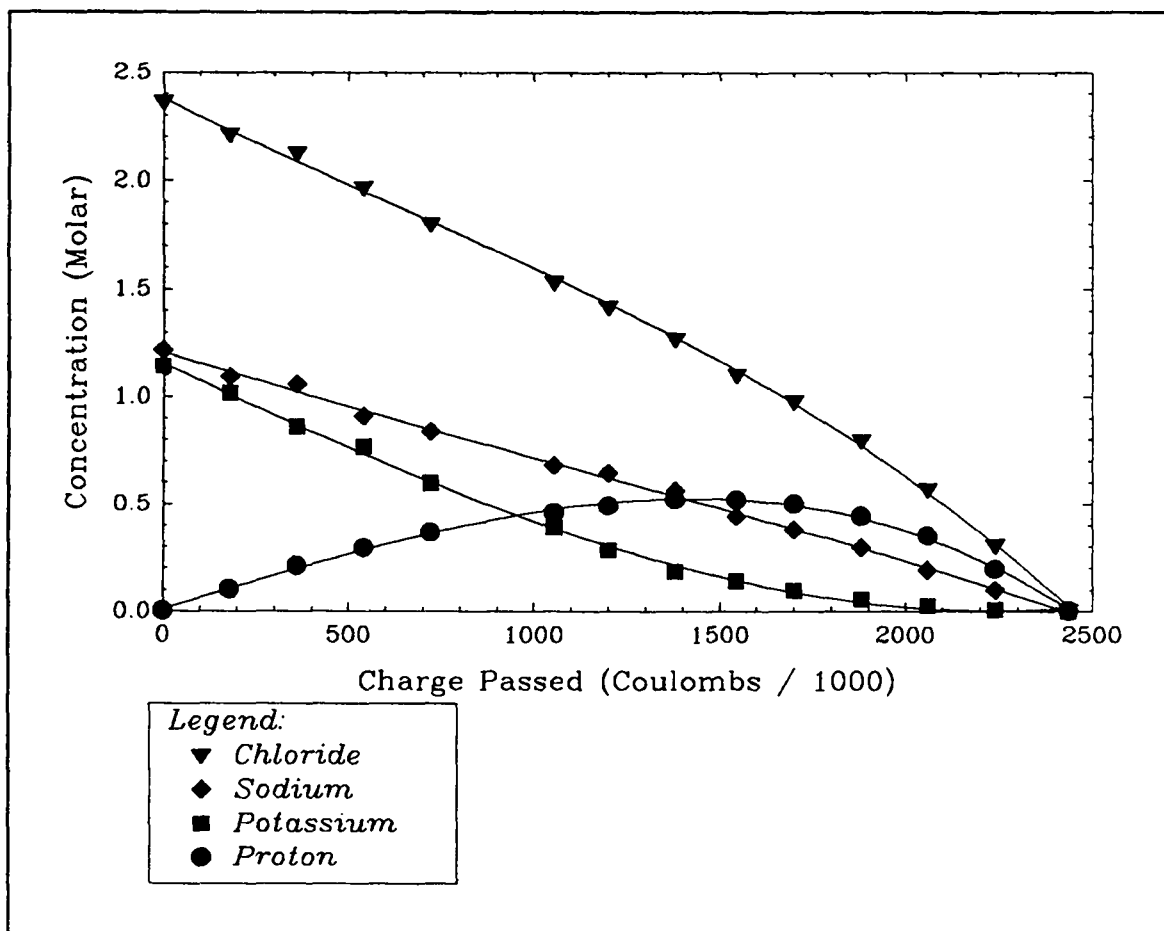

Figure 10: Concentration changes in the feed solution during the stage two electrodiagnosis.

At the start of the electrolysis, potassium carried a larger percentage of the current than did sodium due to its higher mobility. After 1.4×10^6 coulombs a significant fraction of the current was carried by migrating protons which caused the migration of potassium, now present at a much lower concentration, to slow. The flux of sodium remained nearly constant throughout the electrolysis. Eventually the feed stream was deionized to an ionic strength of approximately 10^{-3} M.

The concentration changes in the catholyte are presented as Figure 11. The hydroxide concentration increased at a fixed rate at constant current density due to the steady state generation of hydroxide at the cathode. The concentration of hydroxide in the catholyte reached a maximum of about 8.0 M at 1.4×10^6 coulombs. This corresponded to the point at which the proton concentration within the feed compartment peaked. After this point was reached, proton migration into this compartment approached a steady state. As a result, there was a neutralization of hydroxide by the migrating protons as well as a dilution related to the waters of hydration associated with the migrating cations. When

deionization of the feed was completed, the concentrations of sodium and potassium had converged, with a final hydroxide concentration of 6.0 M.

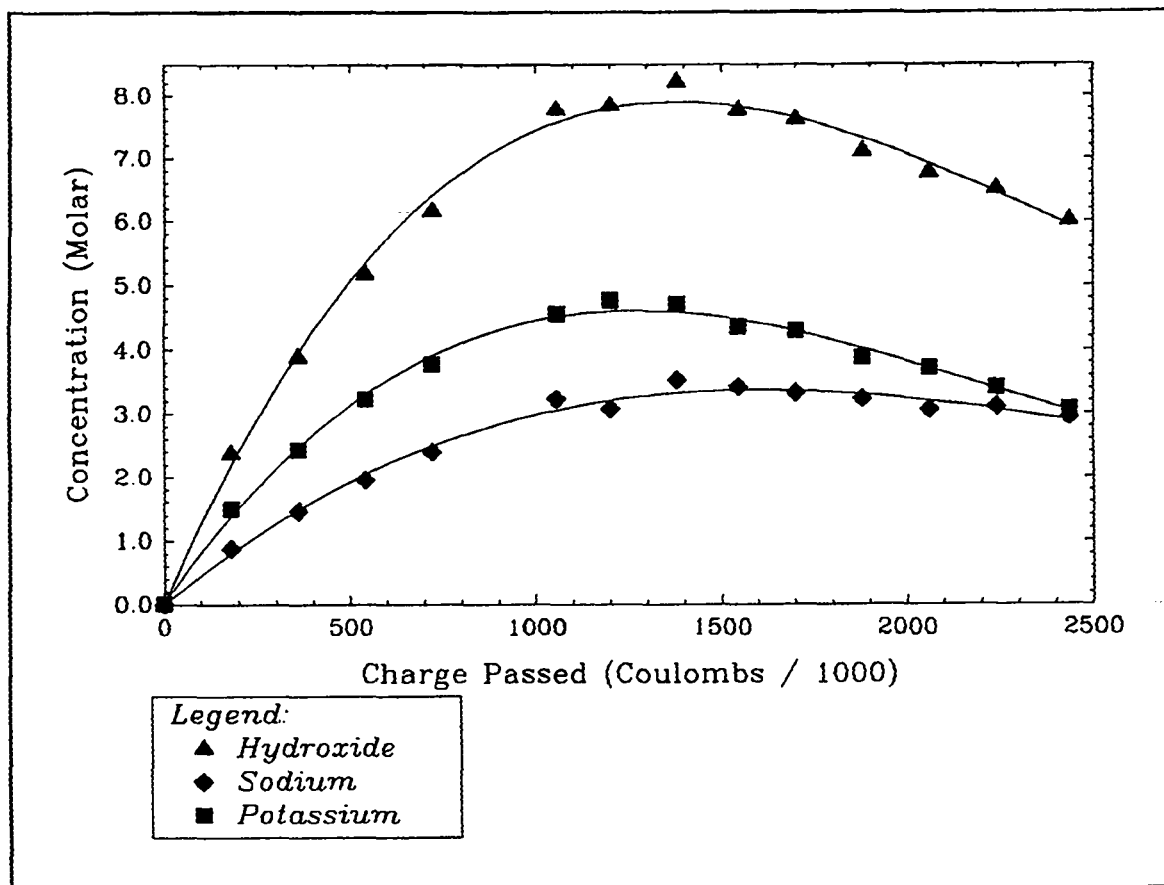

Figure 11: Concentration changes in the catholyte during the stage two electro dialysis.

The concentration changes in the acid concentrate and anolyte solutions are presented as Figure 12. The most significant features of these data are the three regions of the acid concentrate curve. Initially, there was a rapid increase in the concentration of hydrochloric acid within this compartment. This was due to the relatively small volume of this solution compared with that of the feed. Protons migrated from the anolyte compartment at a fixed rate at constant current density. Initially the rate of chloride migration from the feed equaled this rate. As the concentration of hydrochloric acid reached about 2 M, the slope of the curve changed significantly. This decrease resulted from a breakdown in the permselectivity of the anion exchange membrane separating this compartment from the feed. As the acid concentration rose, migration of protons across the anion exchange membrane made up an increasing current component. When this occurred, there was a coinciding decrease in the migration of chloride from the feed compartment while the rate of proton migration from the anolyte remained constant. Eventually a steady state transfer of protons was reached and the concentration of hydrochloric acid reached a maximum of about 3.8 M.

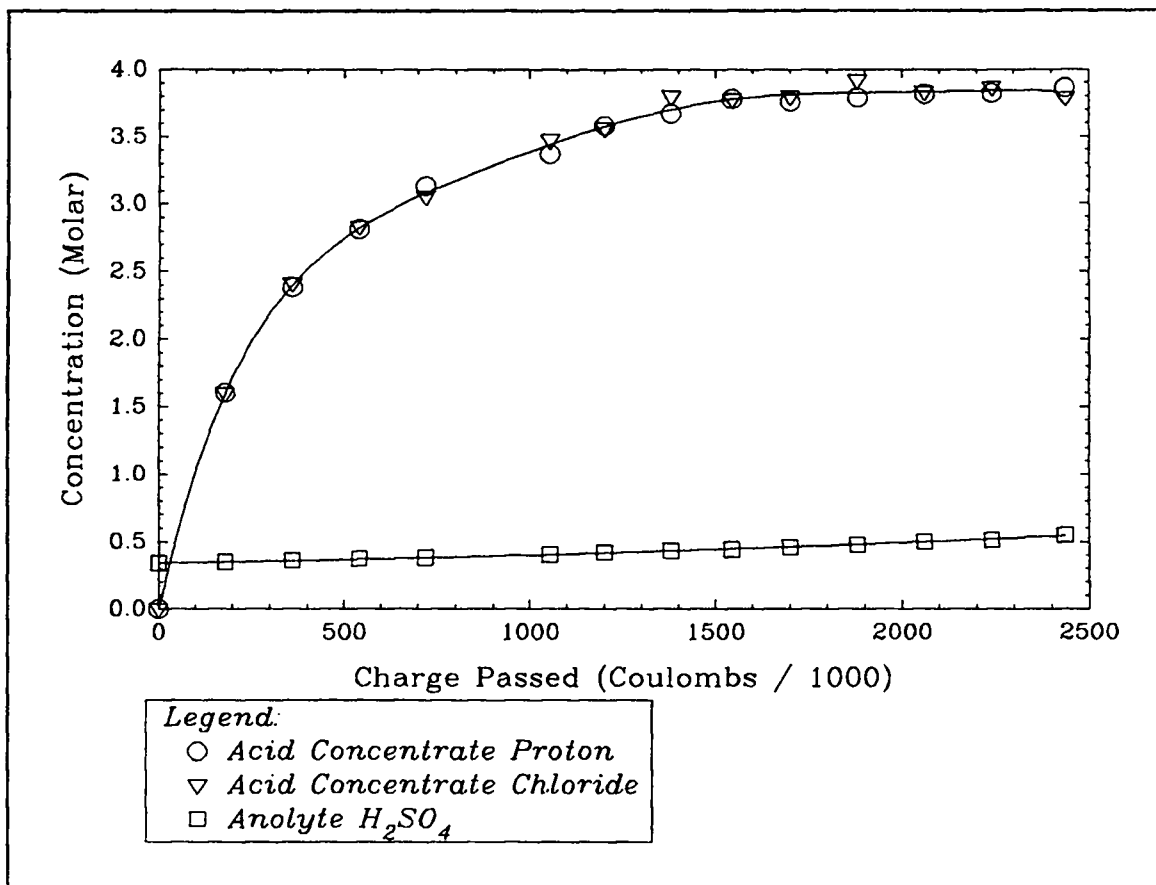

Figure 12: Concentration changes in the anolyte and acid concentrate compartments during a stage two electro dialysis.

The apparent linear increase in the anolyte sulfuric acid concentration was due to waters of hydration on protons migrating from the compartment at a steady state. There was also a small reduction in anolyte volume associated with the electrolysis of water at the anode.

A materials balance for this second stage electrolysis has been calculated and is presented as Figure 13. The feed solution was 4.0 L of a solution initially 1.2 M in both potassium chloride and sodium chloride. This solution was fed into the compartment adjacent to the catholyte of a four-compartment electrolysis cell (refer to Figure 5). A total of 1.0 L of deionized water was fed into the cell, 0.5 L as the catholyte and 0.5 L as the acid concentrate. The anolyte consisted of a 4.5 L solution of 0.3 M sulfuric acid.

The electrolysis was continued until the cell resistance prohibited current passage indicating deionization of the feed solution. During this electrolysis process 6.5 moles of oxygen and 13 moles of hydrogen were evolved at the anode and cathode respectively. Generated in the acid concentrate was 2.5 L of 3.8 M HCl. The anolyte volume decreased from 4.5 L to 2.8 L, resulting in a final sulfuric acid concentration of 0.48 M. The final catholyte volume was 1.6 L and was 3.0 M in both KOH and NaOH for a total OH⁻ concentration of 6.0 M.

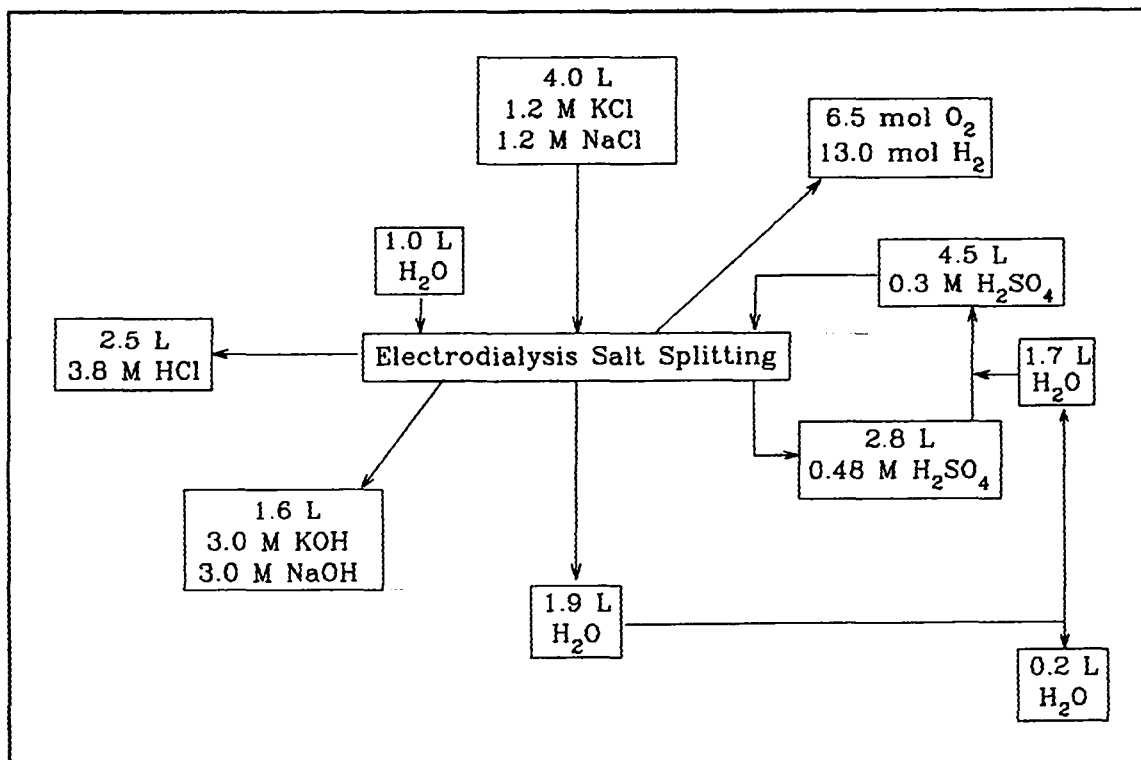

Figure 13. Materials balance for the second stage electrolysis.

Conclusions

From these data, we can calculate an overall materials balance for the treatment of spent electrorefining salts. This overall balance is shown in Figure 14. When 1.6 kg of spent salt is processed, a net input of 10 L of water is required and results in a net production of 6.0 L of 3.8 M hydrochloric acid and 4.3 L of a 2.7 M potassium hydroxide/sodium hydroxide mixture. The total production of gases are 25 moles of hydrogen and 12.5 moles of oxygen. The initial 2 wt% of $\text{NdCl}_3 \cdot 6\text{H}_2\text{O}$ and 0.3 wt% $\text{FeCl}_2 \cdot 6\text{H}_2\text{O}$ are precipitated out as 0.09 mol $\text{Nd}(\text{OH})_3$ and 0.03 mol $\text{Fe}(\text{OH})_2$. There is also a one-time investment of hydrochloric acid for the dissolution of the salt, after which, acid generated by electro dialysis can be used for the dissolution step. Also required is an initial input of sulfuric acid which needs only dilution for recycle within the process.

The electro dialysis treatment of spent electrorefining salts is an attractive alternative to separation methods based on ion exchange. The recycle of reagents within the process and the generation of useful products is very desirable in the wake of stringent environmental regulations which have resulted in increasing costs for waste disposal.

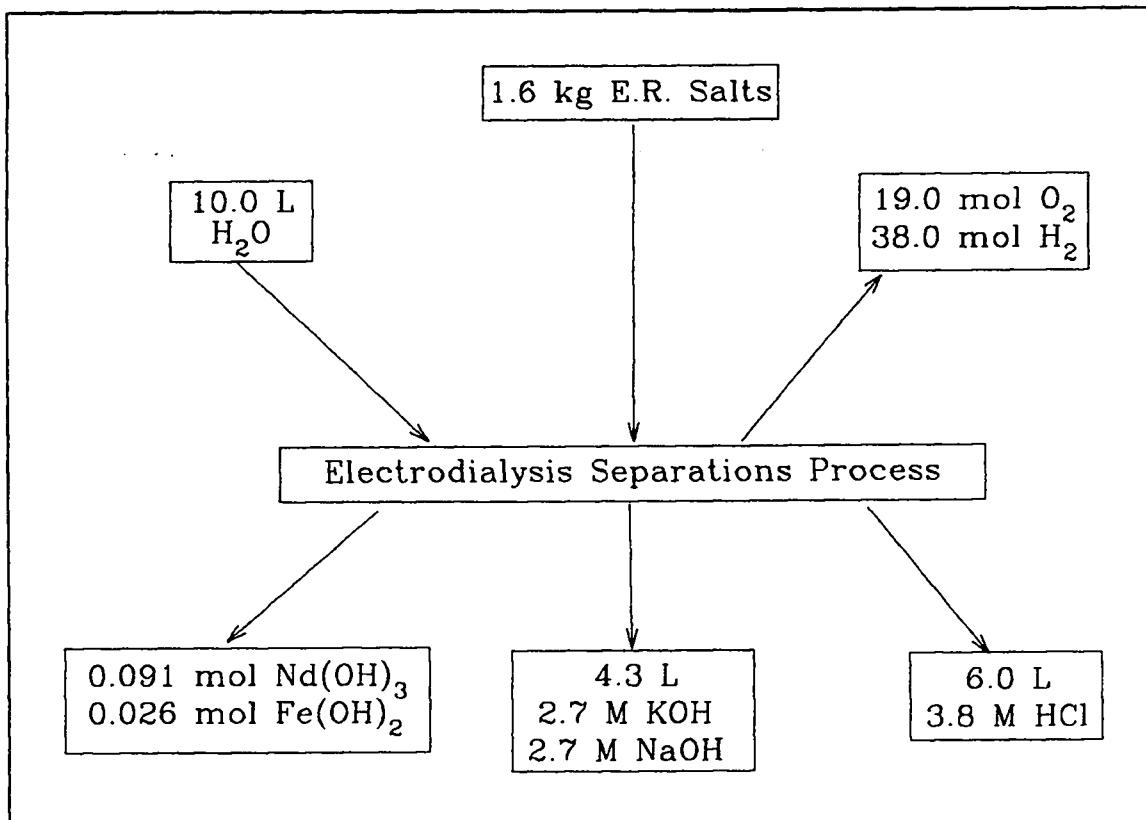

Figure 14: Materials balance for the overall electrodialysis separations process as performed on 1.6 kg of spent electrorefining salts.

References

1. Tosflex is a registered trademark of the Tosoh Corporation, Tokyo, Japan.
2. Nafion is a registered trademark of the E. I. du Pont de Nemours and Co. (Inc.)
3. Nalgene is a registered trade name for the Nalge Company, Rochester, New York.

LOS ALAMOS NAT'L LAB.
LIB. REGISTRATION COLLECTION
RECEIVED

'95 APR 26 AM 2 46

Los Alamos
NATIONAL LABORATORY

Los Alamos, New Mexico 87545